

C41

Water Cooled Resonant Capacitor

Water Cooled Resonant Capacitor C41-BE1~BE3



Characteristics

- Conduction water-cooled
- Polypropylene dielectric
- Low dissipation factor($\text{tg}\delta$), low ESL and low ESR
- High voltage, high frequency and high dv/dt
- High current resistance, excellent heat dissipation

Application

- Widely used in high power and high frequency resonant devices

Technical Data

| | |
|----------------------------------|--|
| ● Reference standards | GB/T 3984-2004 IEC 60110.1 |
| ● Operating temperature range | -40°C~+85°C |
| ● Capacitance range | 0.1 μF ~85 μF |
| ● Rated capacitance | 100kVar-1500 kVar |
| ● Rated voltage | 400VAC-1100VAC |
| ● Tolerance | $\pm 5\%$ $\pm 10\%$ |
| ● Test voltage between terminals | 1.5 U_{NAC} 10s |
| | 3.5 U_{NDC} 10s at 25°C $\pm 5^\circ\text{C}$ |
| ● Dissipation factor | $\text{tg}\delta \leq 5 \times 10^{-4}$ at 25°C $\pm 5^\circ\text{C}$, 1kHz |
| ● Insulation resistance | $R \cdot C \geq 3000\text{s}$, at 100VDC, 25°C $\pm 5^\circ\text{C}$, 60s |
| ● Life expectancy | 100000h at U_{N} and 70°C, 30000h at U_{rms} |

Typical Circuit

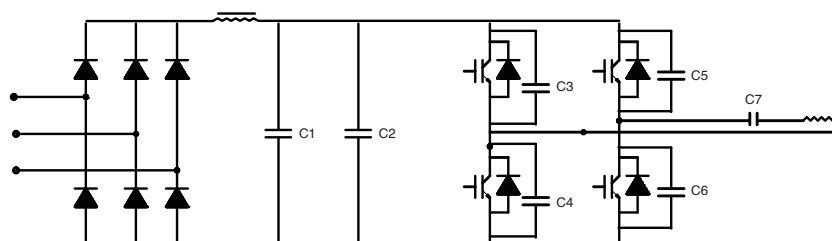

C7 is the water-cooled capacitor in the series resonant capacitor

C41

Water Cooled Resonant Capacitor

Construction Diagram

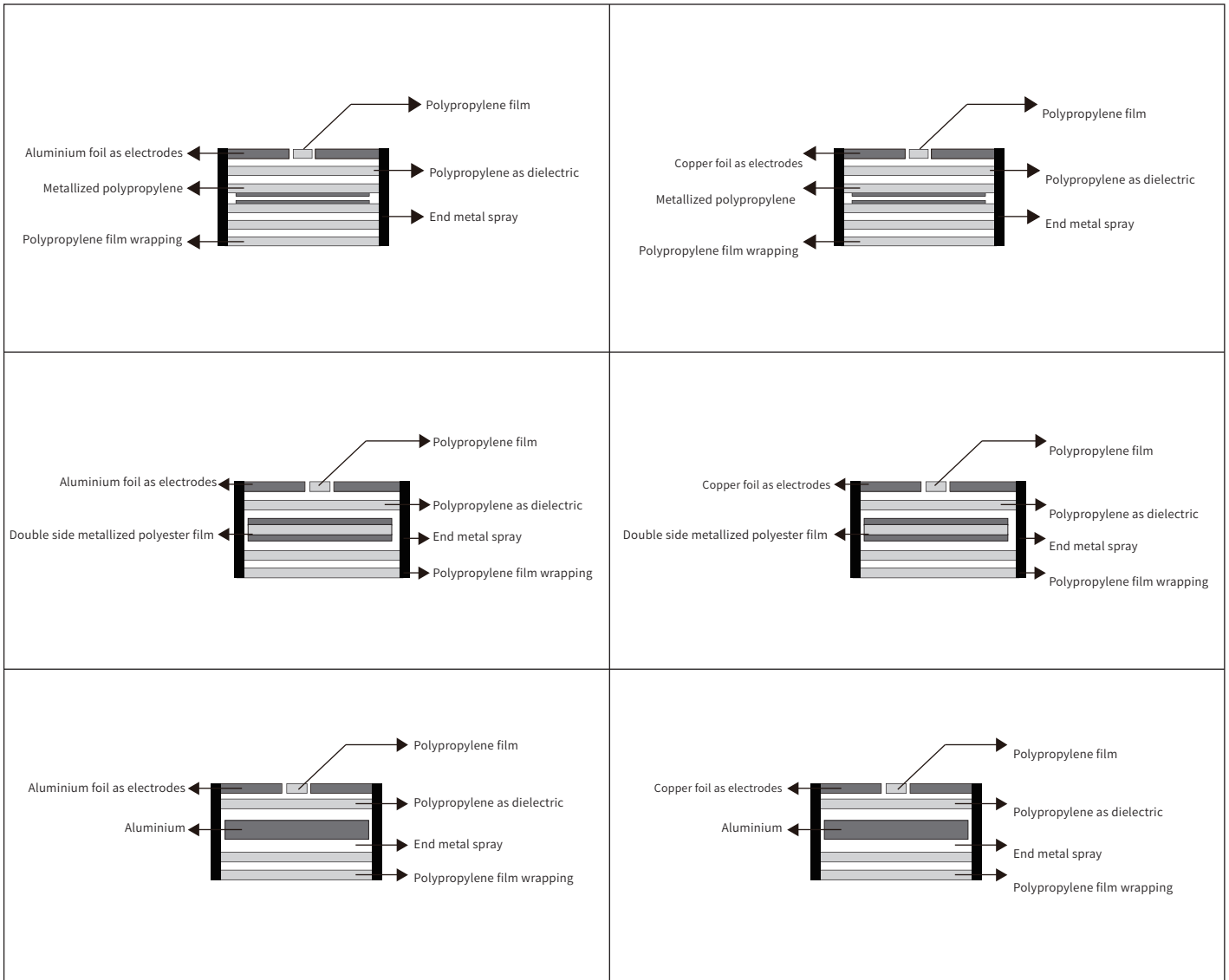

Product Coding

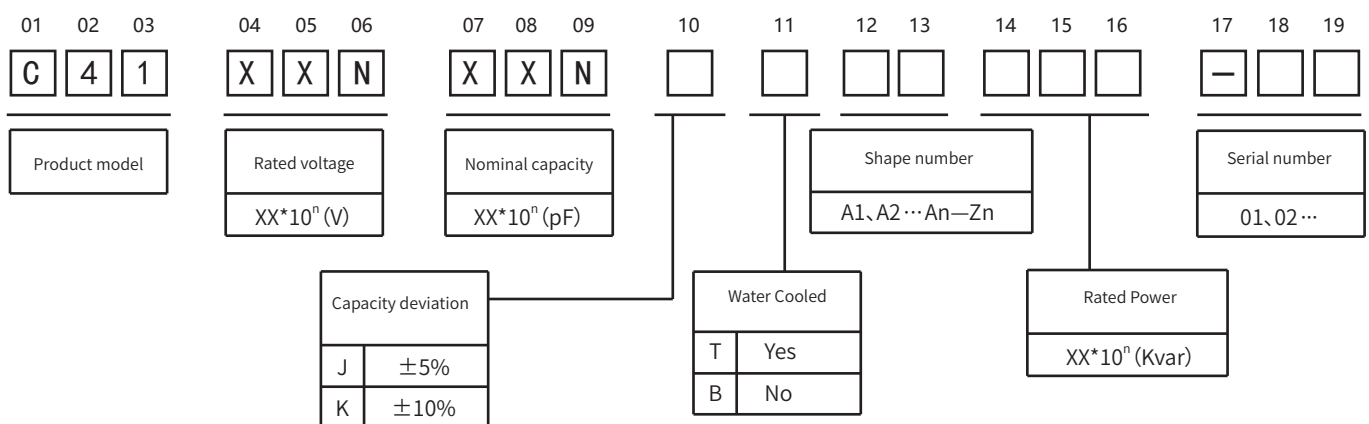

C41

Water Cooled Resonant Capacitor

C41—BE1~BE3

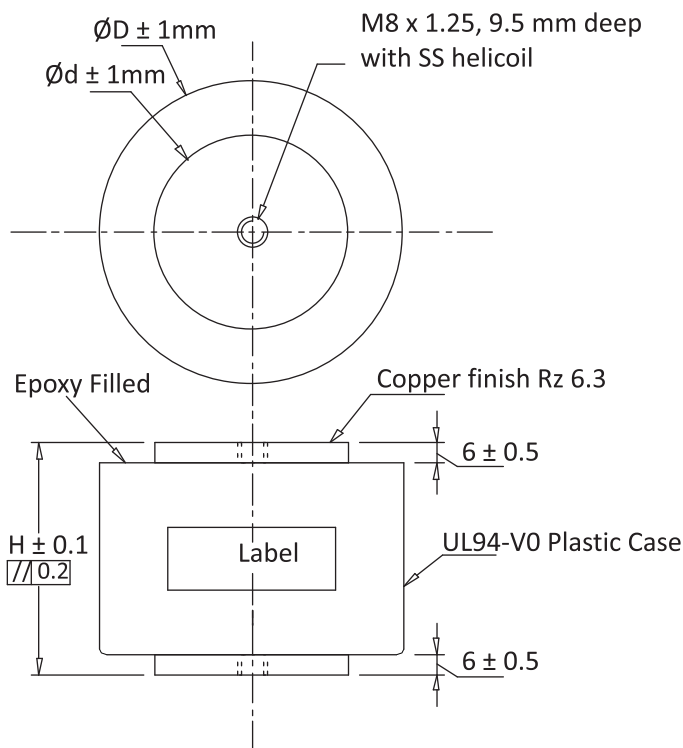

Article Table

| Part Number | Rated Voltage Vrms | Nominal Capacitance μF at 1Khz | Max Irms A | Max Power kVar | Freq Range @Full Power (kHz) | ESR m Ω | Dimension (mm) | | | Case Code |
|---------------------|-----------------------|--|---------------|-------------------|------------------------------------|-------------------|----------------|------|----------------|-----------|
| | | | | | | | ΦD | H | Φd | |
| C41112125KBE1501... | 1100 | 1.2 | 600 | 500 | 55-96 | 1.5 | 88 | 71.5 | 60 | BE1 |
| C41112145KBE1501... | 1100 | 1.4 | 600 | 500 | 46-83 | 1.2 | 88 | 71.5 | 60 | BE1 |
| C41751305KBE1501... | 750 | 3.0 | 800 | 500 | 47-68 | 1.1 | 88 | 71.5 | 60 | BE1 |
| C41751335KBE1501... | 750 | 3.3 | 800 | 500 | 43-62 | 1.0 | 88 | 71.5 | 60 | BE1 |
| C41701565KBE1501... | 700 | 5.6 | 1000 | 500 | 29-57 | 0.9 | 88 | 71.5 | 60 | BE1 |
| C41701635KBE1501... | 700 | 6.3 | 1000 | 500 | 26-51 | 0.8 | 88 | 71.5 | 60 | BE1 |
| C41501216KBE1501... | 500 | 21 | 1000 | 500 | 15 | 0.4 | 88 | 71.5 | 60 | BE1 |
| C41701855KBE2501... | 700 | 8.5 | 1000 | 500 | 19-38 | 0.7 | 98 | 71.5 | 60 | BE2 |
| C41701106KBE2501... | 700 | 10 | 1000 | 500 | 16-32 | 0.6 | 98 | 71.5 | 60 | BE2 |
| C41901405KBE3501... | 900 | 4.0 | 700 | 500 | 25-39 | 0.9 | 110 | 71.5 | 60 | BE3 |
| C41551276KBE3501... | 550 | 27 | 1000 | 500 | 10-12 | 0.3 | 110 | 71.5 | 60 | BE3 |
| C41501336KBE3501... | 500 | 33 | 1000 | 500 | 10 | 0.3 | 110 | 71.5 | 60 | BE3 |
| C41501376KBE3501... | 500 | 37 | 1000 | 500 | 9 | 0.2 | 110 | 71.5 | 60 | BE3 |

The above table / graphics are for reference only, subject to the actual product (unit: mm)

C41

Water Cooled Resonant Capacitor

Temperature Characteristics

—◆— Voltage —■— Current —▲— Power

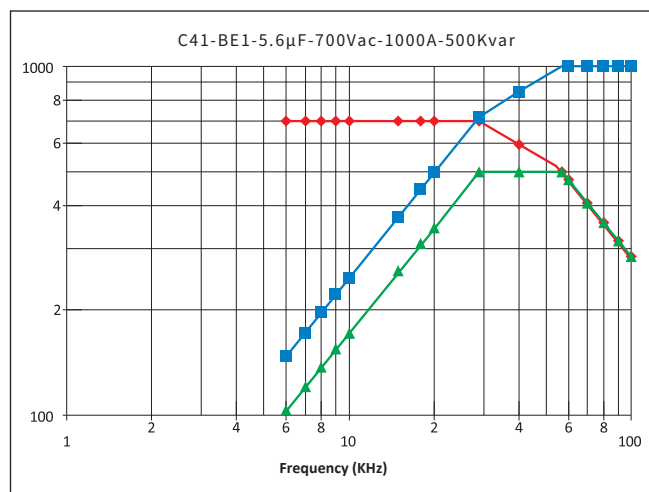
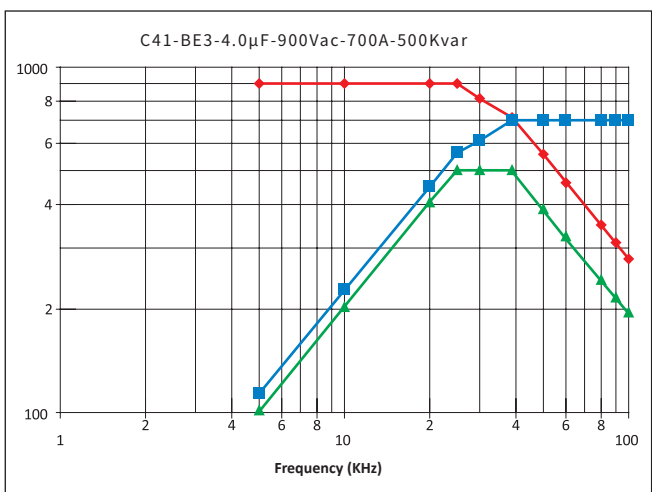
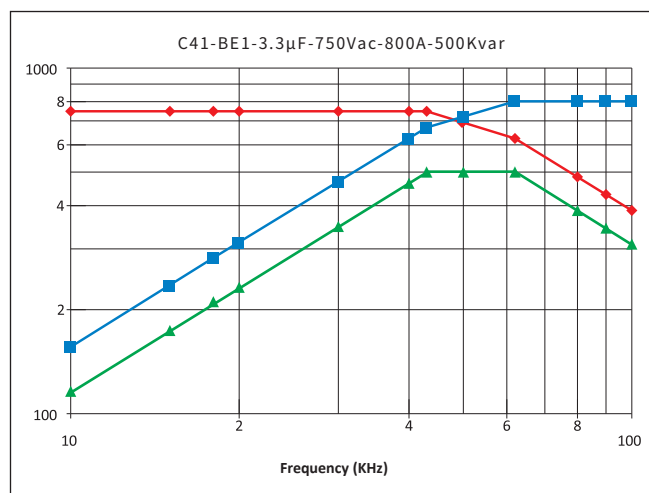
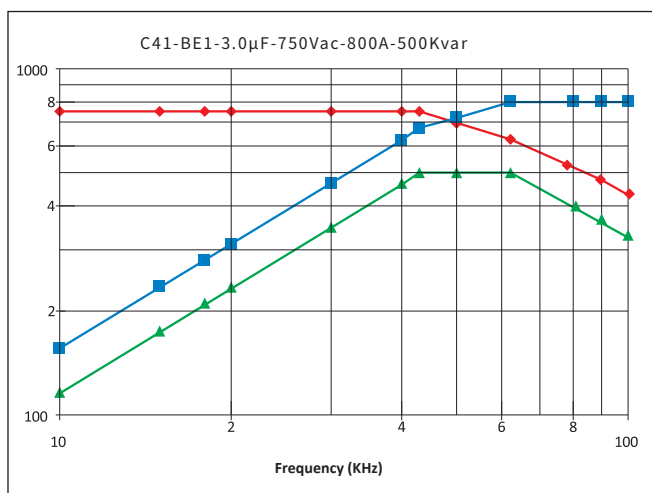
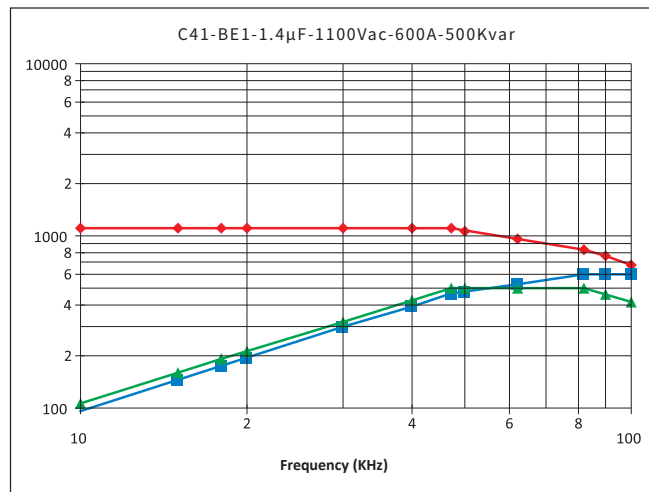
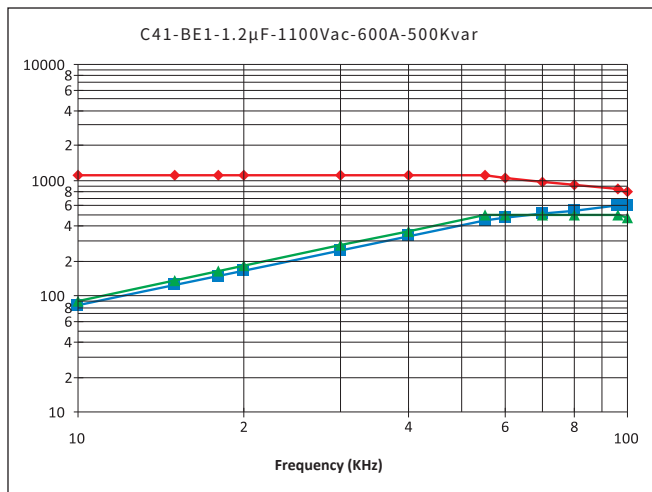

C41

Water Cooled Resonant Capacitor

Temperature Characteristics

—●— Voltage —■— Current —▲— Power

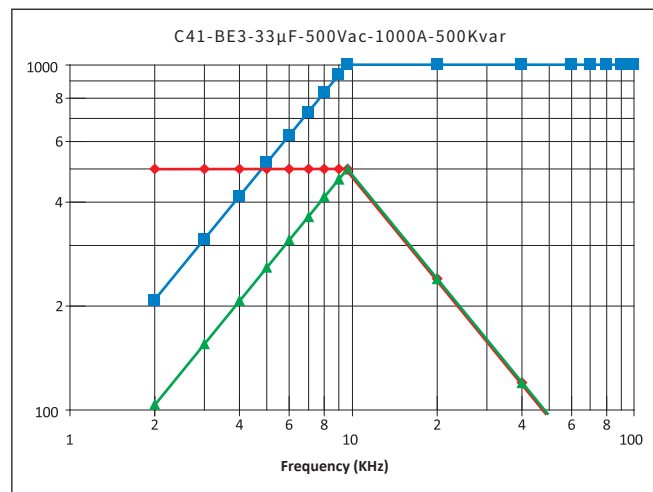
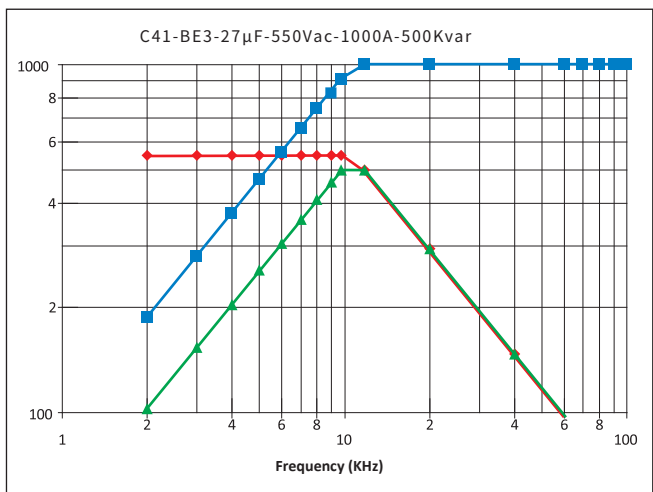
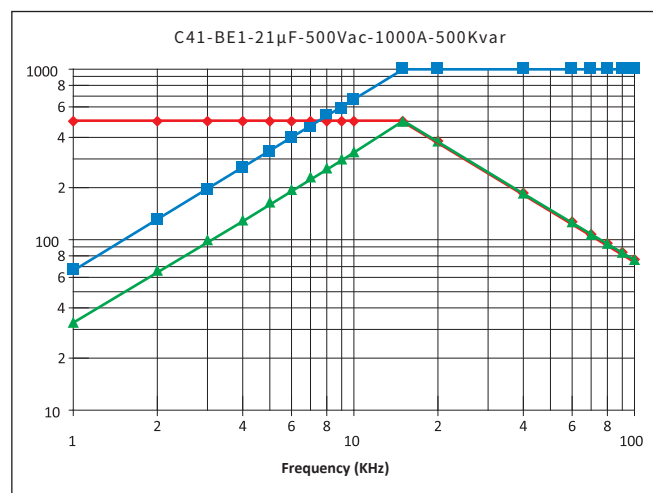
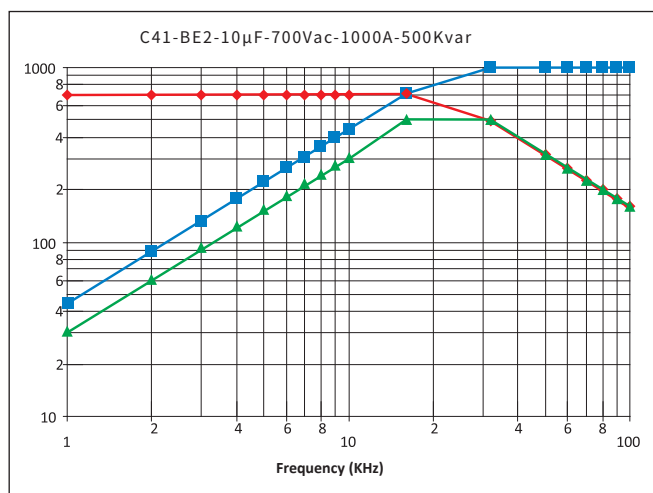
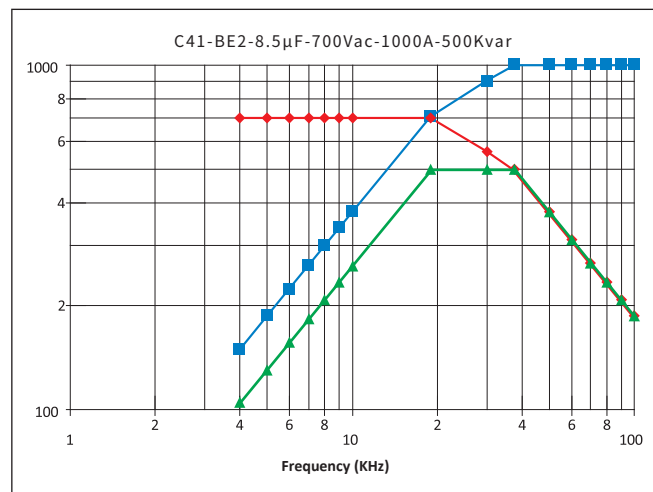
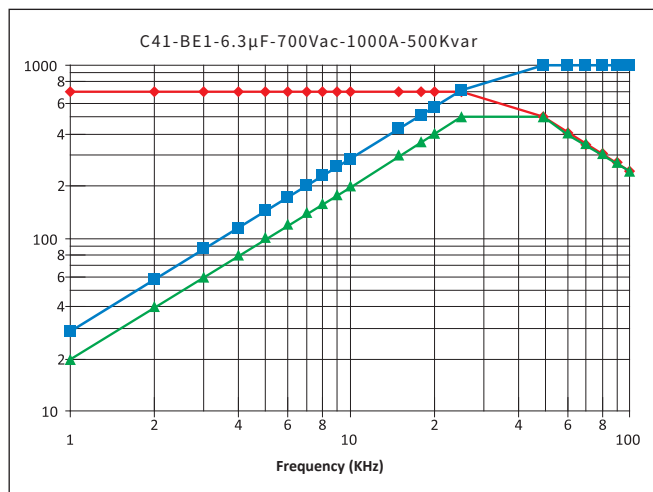

C41

Water Cooled Resonant Capacitor

Temperature Characteristics

—◆— Voltage —■— Current —▲— Power

